

# MOD. VB110

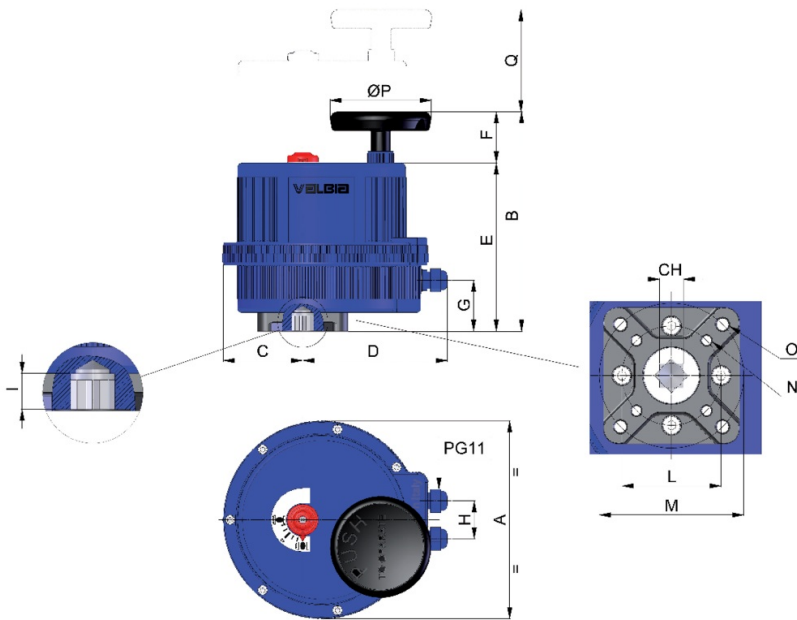

## Technical specifications



SIZE	PATTERN ISO 5211	CH	A	B	C	D	E	F	G	H	I	L	M	N	O	ØP	Q
VB110	F07-F10	17	8.31	9.14	3.31	6.02	7.01	2.13	2.13	1.58	0.75	2.76	4.02	5/16-18 UNC 2BX0.75	3/8-16 UNC 2BX0.75	4.33	4.53

# Certifications

---



CSA International