

# MOD. VB350

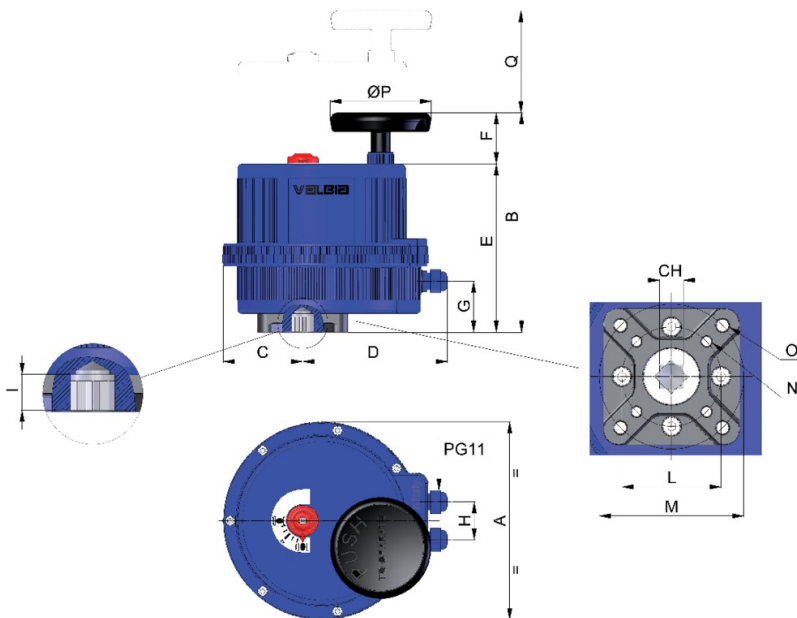

## Technical specifications



SIZE	PATTERN ISO 5211	CH	A	B	C	D	E	F	G	H	I	L	M	N	O	ØP	Q
VB350	F07-F10	22	8.74	9.19	3.03	6.69	7.17	2.03	2.13	1.58	0.95	2.76	4.02	5/16-18 UNC 2BX0.79	3/8-16 UNC 2BX0.75	4.33	4.53

# Certifications

---



CSA International