

8E868

Electric actuator with 2 way brass ball valve direct mount (RB 253N).

OPERATING CONDITIONS: fluid H₂O - T 68°F



Technical specifications

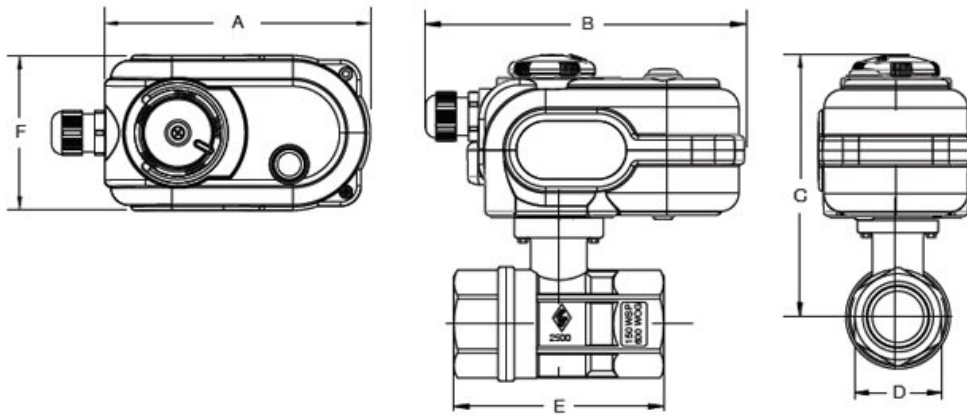

SIZE	PSI	A	B	C	D	E	F	ACT.
-	1000	5.11	6.14	5.91	1.61	3.35	2.95	VB 010
-	1000	5.11	6.14	6.23	1.97	3.66	2.95	VB 010
-	1000	5.11	6.14	5.09	1.06	2.64	2.95	VB 010
-	1000	5.11	6.14	5.09	1.06	2.64	2.95	VB 010
-	1000	5.11	6.14	5.29	1.26	3.00	2.95	VB 010
-	1000	5.11	6.14	5.09	1.06	2.64	2.95	VB 010