



## GN500N

### NYLON 11 COATED DISC

Gear operated Wafer butterfly valves full port.

- Epoxy coated cast iron wafer body.
  - Pressure rating: 250psi water (40°F to 80°F).
  - Food grade EPDM resilient seat -30°F to 250°F.
  - Low turn ratio.
  - API609 face to face flange.
  - Floating dual shaft disc design.
  - IP54 enclosure.
  - MSS SP 67 compliant.
  - No pins in disc prevent potential leak points.
  - NSF certified for drinking water service (EPDM seats only).
  - Dead end service to 100 psi.
- G530S: VITON® SEATS - size 2" to 12".  
G540S: BUNA-N SEATS - size 12" to 12".

## Technical specifications

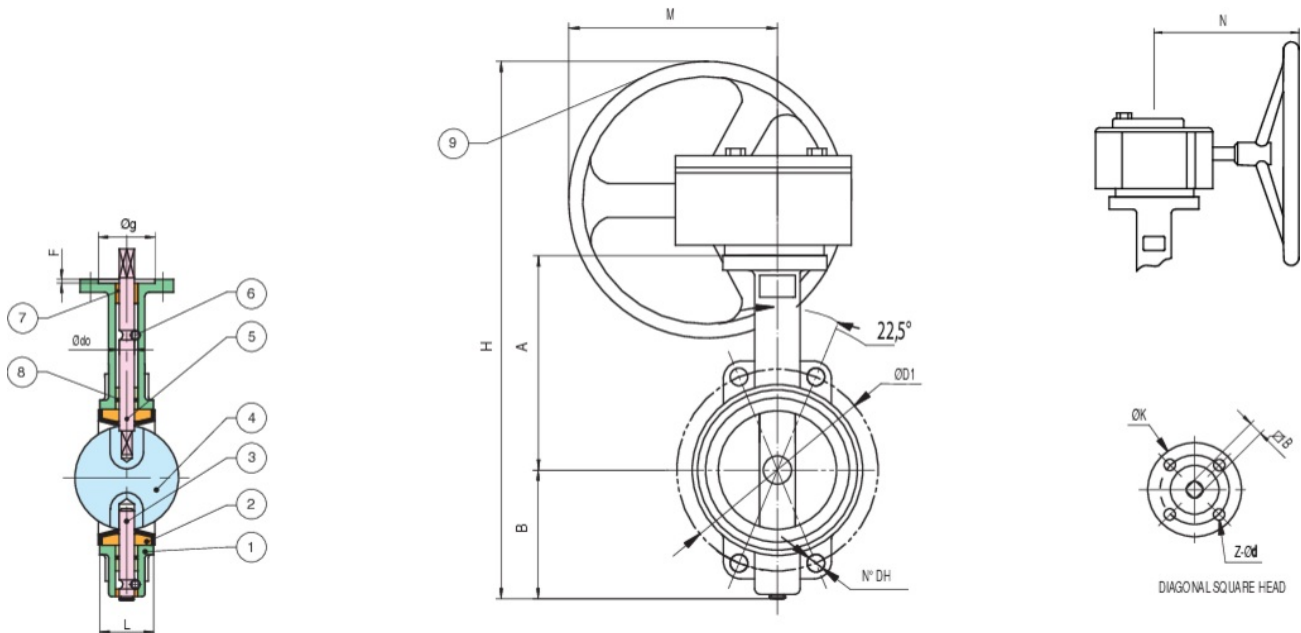

POSITION	PART NAME	MATERIAL	N.º PIECES
1	BODY	CAST IRON	1
2	SEAT	EPDM (30F TO 250F)	1
3	LOWER SHAFT	AISI 416	1
4	DISC G500N	IRON NYLON 11	1
5	UPPER SHAFT	AISI 416	1
6	LOCATING PIN	CARBON STEEL	1
7	BUSHING	PTFE	1
8	O-RING	EPDM	1
9	GEAR	CAST IRON	1

SIZE	ISO 5211	ØB	A	B	L	H	M	N	ØDO	ØK	Z-ØD	ØG	F	ØD1	Nº-DH	WEIGHT LBS	SEAT TORQUE 100 PSI	SEAT TORQUE 200 PSI	CV (GPM@ 1 PSI) 50% OP	CV (GPM@ 1 PSI) 100% OP
1 1/2"	F05	9 mm	7.24	2.97	1.61	13.12	4.75	6.00	0.50	3.03	4-0.28	1.38	0.12	4.74	4-0.75	16.3	111	133	35	108
2"	F05	9 mm	7.60	3.15	1.65	13.93	4.75	6.00	0.50	3.03	4-0.28	1.38	0.12	4.74	4-0.75	17	126	146	49	146
2 1/2"	F05	9 mm	8.15	3.50	1.76	14.83	4.75	6.00	0.50	3.03	4-0.28	1.38	0.12	5.49	4-0.75	18.6	134	167	84	284
3"	F05	9 mm	8.38	3.74	1.78	15.31	4.75	6.00	0.50	3.03	4-0.28	1.38	0.12	6.00	4-0.75	19.9	205	223	128	547
4"	F07	11 mm	9.13	4.49	2.05	16.8	4.75	6.00	0.62	3.54	4-0.35	2.17	0.12	7.50	4-0.75	22.3	339	386	195	844
5"	F07	14 mm	9.60	5.00	2.14	17.78	4.75	6.00	0.75	3.54	4-0.35	2.17	0.12	8.50	4-0.87	26.9	523	602	320	1375
6"	F07	14 mm	10.16	5.47	2.20	18.81	4.75	6.00	0.75	3.54	4-0.35	2.17	0.12	9.50	4-0.87	28.7	677	996	418	1882
8"	F10	17 mm	12.01	6.89	2.34	24.73	8.35	9.84	0.87	4.92	4-0.47	2.76	0.14	11.75	4-0.87	57.8	1205	1864	745	3340
10"	F10	22 mm	13.27	7.99	2.58	27.03	8.35	9.84	1.12	4.92	4-0.47	2.76	1.40	14.25	4-1.00	70.9	1890	3140	1264	5475
12"	F10	22 mm	15.04	9.53	3.03	30.34	9.06	8.94	1.24	5.51	4-0.47	2.76	1.40	17.00	4-1.00	104.6	2808	4767	1905	8270

## Certifications



NSF

NSF/ANSI  
61, 302  
EPDM SEATS  
ONLY

NSF-ANSI